

TELA MOSQUITEIRA RECOLHÍVEL
 HORIZONTAL 1 FOLHA

INSTRUÇÕES DE MONTAGEM

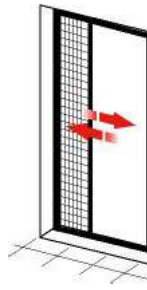

1 MEDIR A LARGURA (L) E A ALTURA (H) DO VÃO

Exemplo:
 L: 140 cm
 H: 230 cm

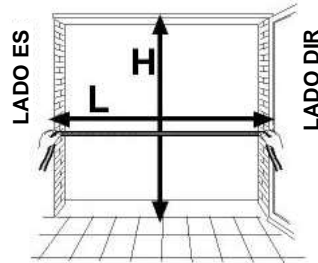

2 CORTE DA "CAIXA DA TELA" COMPLETO

- certifique-se de que os perfis estejam bem alinhados nas extremidades
- certifique-se de que a tela esteja firmemente enrolada em torno do tubo

O corte deve ser feito cortando a "Caixa da Tela" na medida da Altura (H) menos 2,2 cm

Exemplo:
 H (vão) 230 cm = cortar a caixa da tela a 227,8 cm

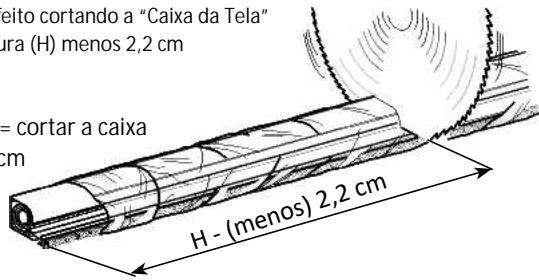

3 INVERTER O "PERFIL PUXADOR"

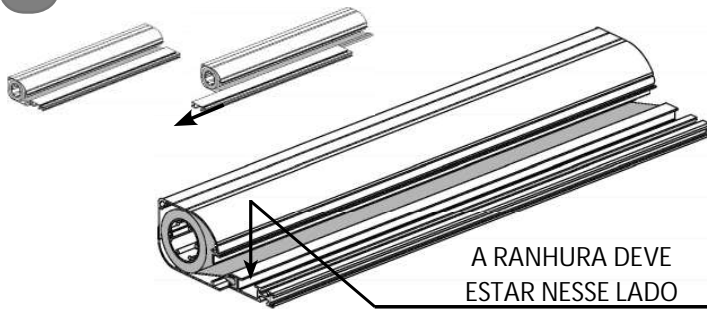

4 CORTAR A GUIA SUPERIOR

Exemplo:
 L vão (140 cm) = cortar a 134,8 cm

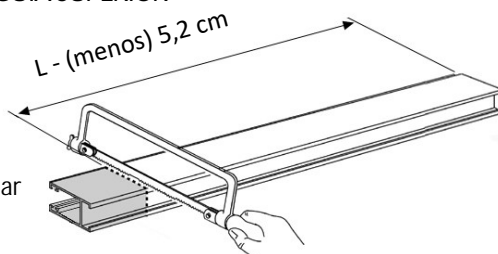

5 CORTAR A GUIA INFERIOR

Exemplo:
 L vão (140 cm) = cortar a 134,8 cm

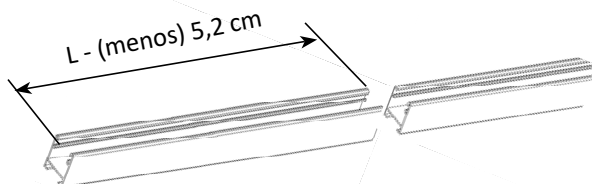

6 CORTAR O PERFIL DE REFORÇO

Exemplo:
 H vão (230 cm) = cortar o perfil a 217,3 cm

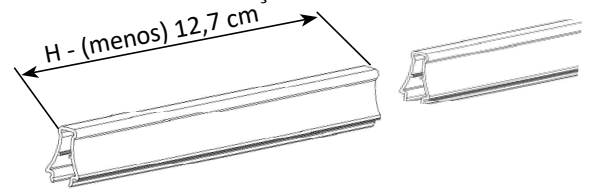

7 CORTAR O PERFIL BATENTE A "U"

Exemplo:
 H vão (230 cm) = cortar o perfil a 229,8 cm

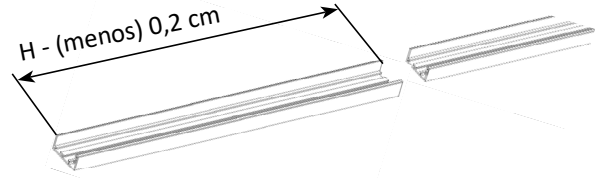

8 MONTAGEM DOS ACESSÓRIOS NO PERFIL PUXADOR E NO PERFIL DE REFORÇO

8.1 Pré-montagem da tampa-carrinho inferior e tampa superior

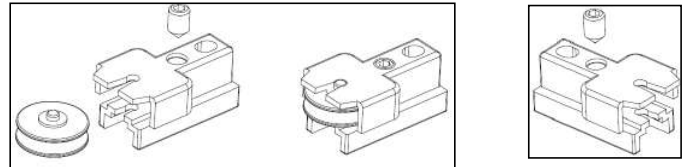

8.2 Montagem da tampa inferior e da tampa-carrinho

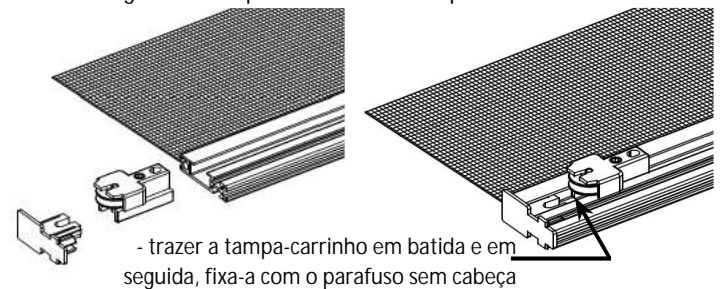

8.3 inserção de perfil de reforço, puxador externo e imã

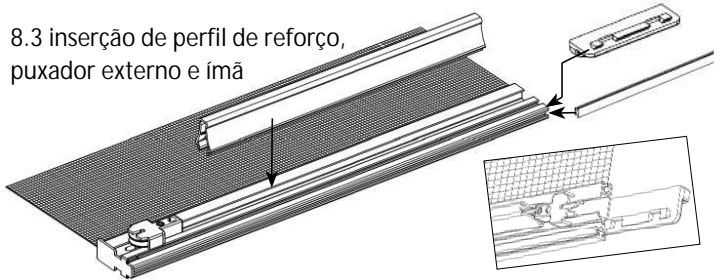

8.4 inserção de tampas na parte superior do perfil puxador

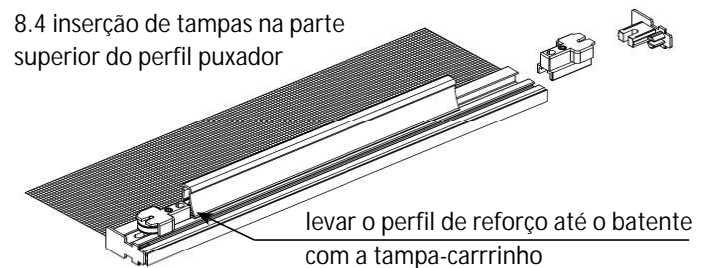

9 INSERÇÃO DA TAMPA SUPERIOR

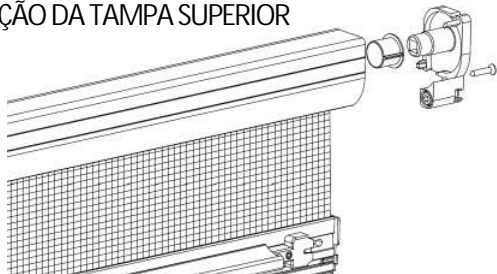

10 INSERÇÃO DA MOLA

PRE-CARREGAMENTO DA MOLA: 16 ROTAÇÕES (GIROS)

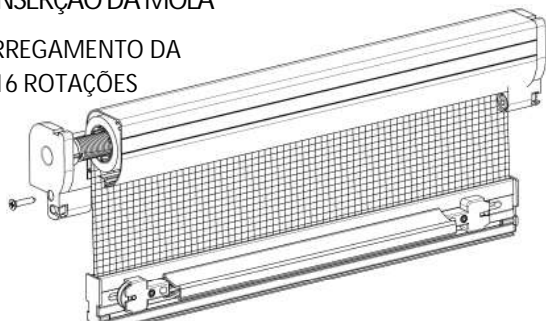

11 COLOCAÇÃO DA CAIXA DA TELA NO VÃO



- a mola de compensação deve ser colocada sempre na parte superior (mesmo com a montagem da caixa da tela a direita)

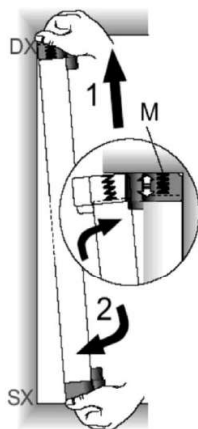
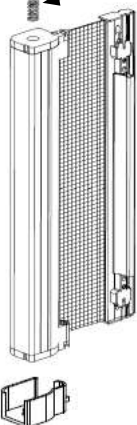

12 FIXAÇÃO DO PERFIL BATENTE



alinhamento dos ímãs, caixa da tela e perfil batente

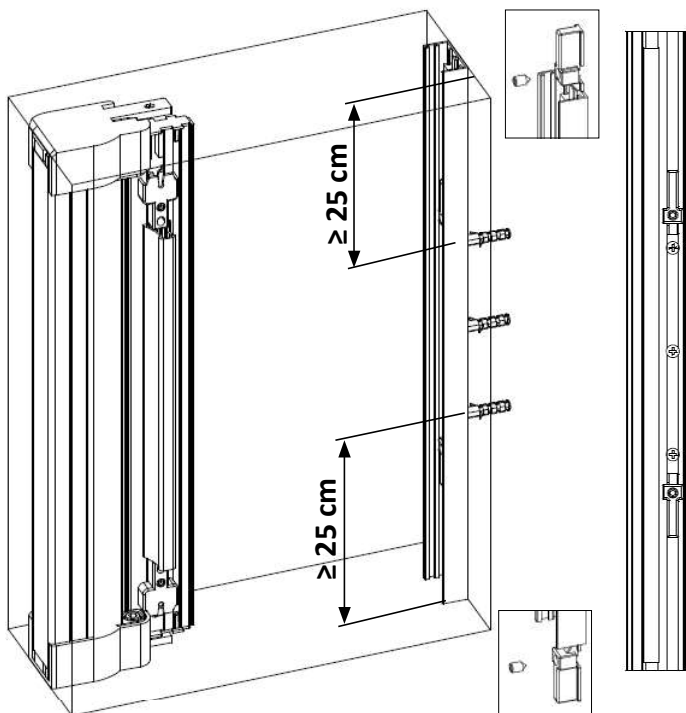

13 COLOCAÇÃO DA GUIA SUPERIOR E INFERIOR

- inserir primeiro a guia superior e depois a inferior

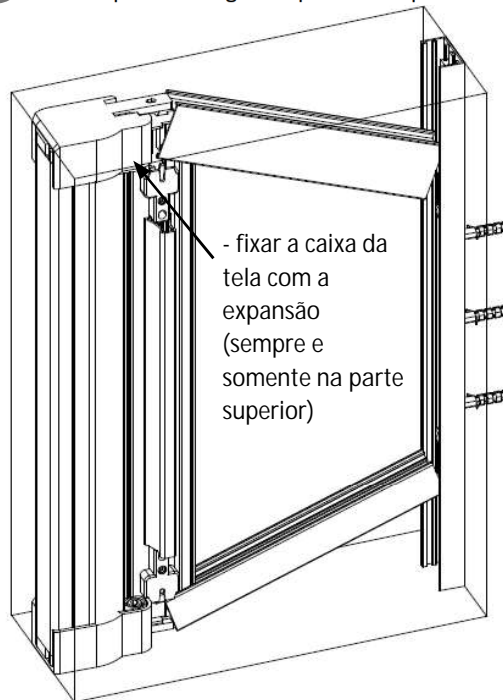

- fixar a caixa da tela com a expansão (sempre e somente na parte superior)

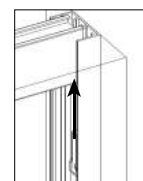

- posicionar os elementos de bloqueio da guia e apertar os pinos

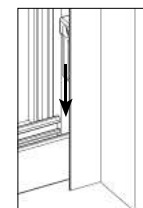

14 AJUSTE DA TAMPA SUPERIOR, INSERÇÃO DAS PLACAS DE COBERTURA

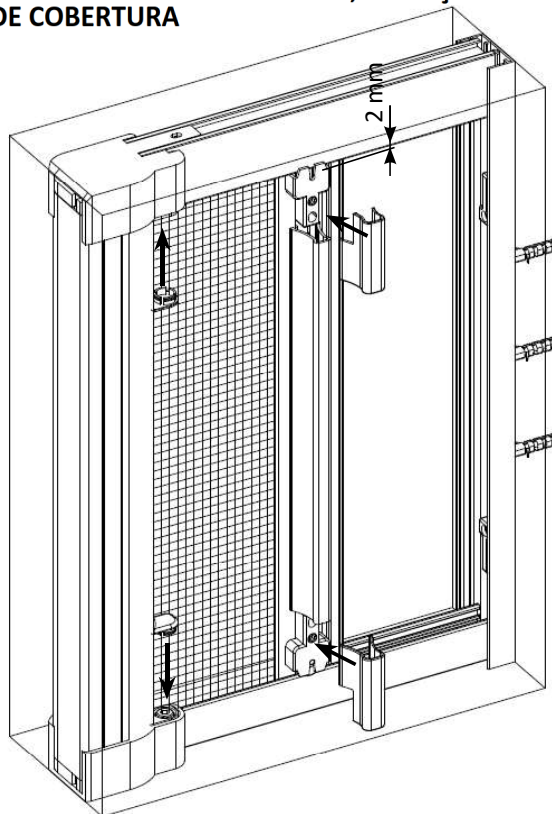

Montagem da caixa da tela a esquerda ou a direita

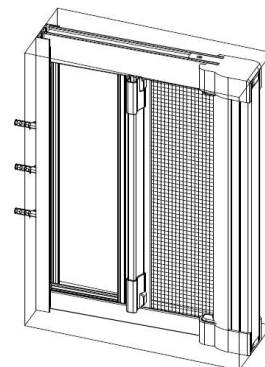
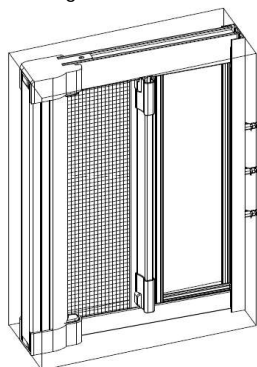

Rodovia PR 158, n° 17400
Distrito Industrial - Vitorino(PR)
CEP 85520-000
Fone: +55 (46) 2604-0048

MEDAL
TELAS MADE IN ITALY